

SPECIAL DESIGNS CAN BE MADE TO ORDER

Bent or machined designs for transformer secondary connections, including series or parallel bars, as well as gun mounted adapters. Use of adapters will take the strain off weld cables that are severely bent at their attachment ends, which improves cable life.

ZJCA-S133

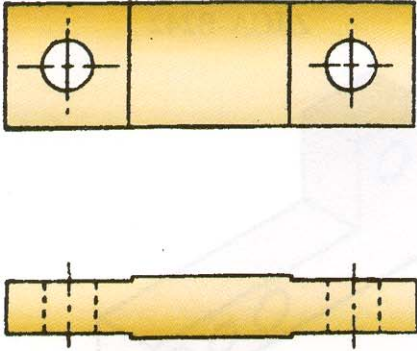

ZJCA-S176

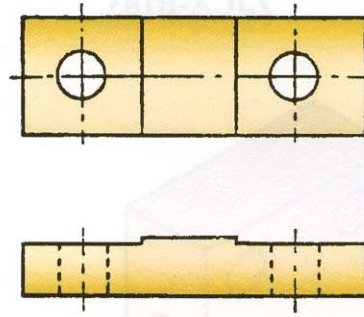

ZJCA-S152

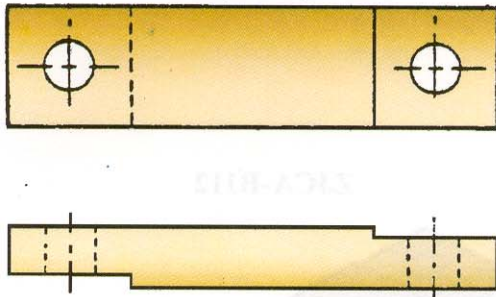

ZJCA-S178

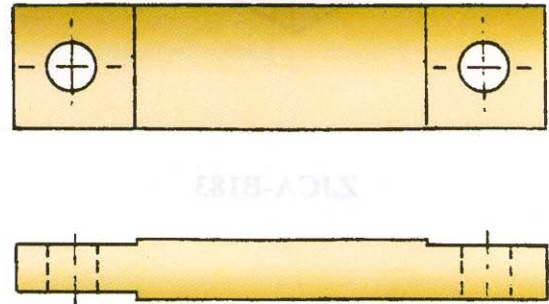

ZJCA-B90

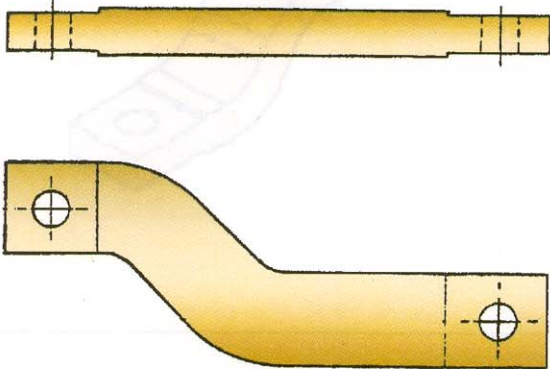

ZJCA-B105

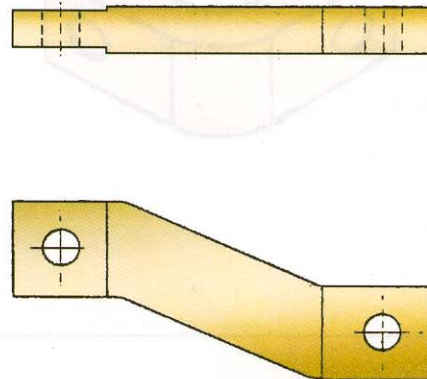

ZJCA-B117

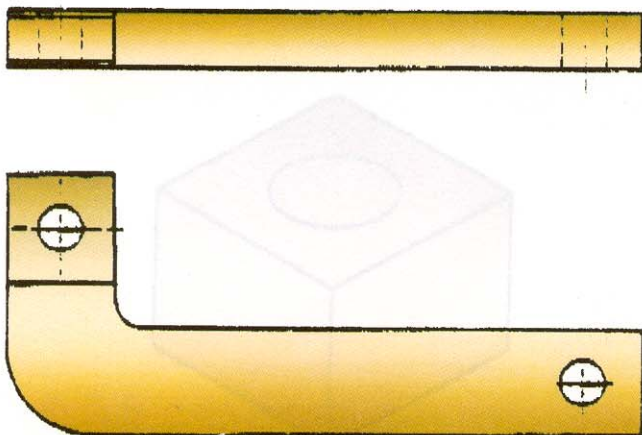

ZJCA-B156

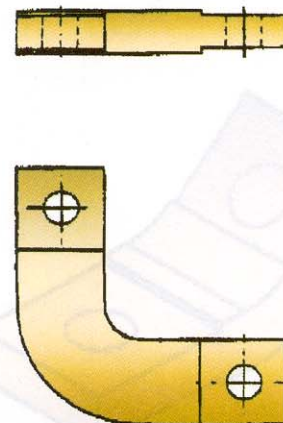

SPECIAL DESIGNS CAN BE MADE TO ORDER

CABLE ADAPTERS

ZJCA-B183

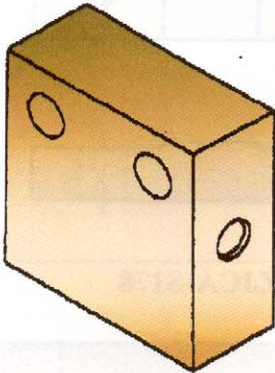

ZJCA-B242

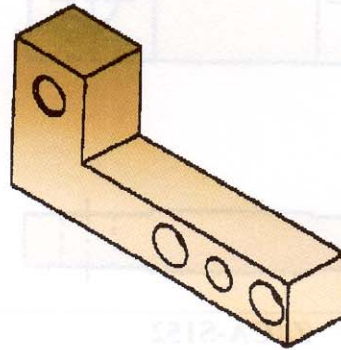

ZJCA-B183

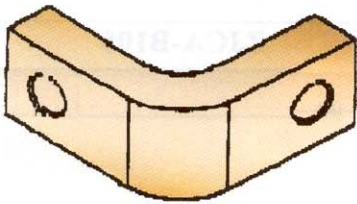

ZJCA-B112

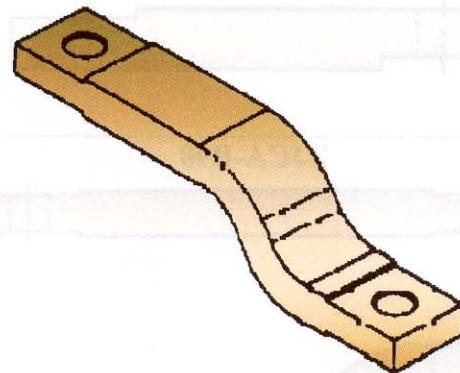

ZJCA-B111

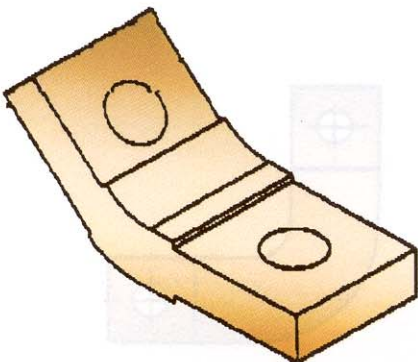

ZJCA-4210-08

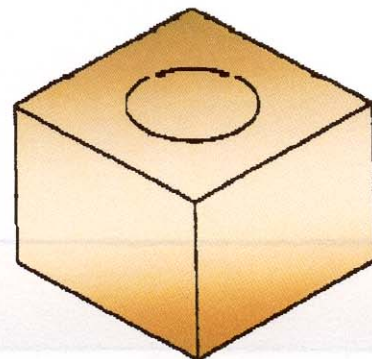

SPECIAL DESIGNS CAN BE MADE TO ORDER