

Item No.	A	B	Item No.	A	B
ZJ60M244	3.00	1.00	ZJ60M246	3.00	1.50
ZJ60M264	3.25	1.00	ZJ60M266	3.25	1.50
ZJ60M284	3.50	1.00	ZJ60M286	3.50	1.50
ZJ60M304	3.75	1.00	ZJ60M306	3.75	1.50
ZJ60M324	4.00	1.00	ZJ60M326	4.00	1.50
ZJ60M344	4.25	1.00	ZJ60M346	4.25	1.50
ZJ60M364	4.50	1.00	ZJ60M366	4.50	1.50
ZJ60M384	4.75	1.00	ZJ60M386	4.75	1.50
ZJ60M404	5.00	1.00	ZJ60M406	5.00	1.50
ZJ60M245	3.00	1.25	ZJ60M247	3.00	1.75
ZJ60M265	3.25	1.25	ZJ60M267	3.25	1.75
ZJ60M285	3.50	1.25	ZJ60M287	3.50	1.75
ZJ60M305	3.75	1.25	ZJ60M307	3.75	1.75
ZJ60M325	4.00	1.25	ZJ60M327	4.00	1.75
ZJ60M345	4.25	1.25	ZJ60M347	4.25	1.75
ZJ60M365	4.50	1.25	ZJ60M367	4.50	1.75
ZJ60M385	4.75	1.25	ZJ60M387	4.75	1.75
ZJ60M405	5.00	1.25	ZJ60M407	5.00	1.75

Item No.	A	B	Item No.	A	B
ZJ61M244	3.00	1.00	ZJ61M246	3.00	1.50
ZJ61M264	3.25	1.00	ZJ61M266	3.25	1.50
ZJ61M284	3.50	1.00	ZJ61M286	3.50	1.50
ZJ61M304	3.75	1.00	ZJ61M306	3.75	1.50
ZJ61M324	4.00	1.00	ZJ61M326	4.00	1.50
ZJ61M344	4.25	1.00	ZJ61M346	4.25	1.50
ZJ61M364	4.50	1.00	ZJ61M366	4.50	1.50
ZJ61M384	4.75	1.00	ZJ61M386	4.75	1.50
ZJ61M404	5.00	1.00	ZJ61M406	5.00	1.50
ZJ61M245	3.00	1.25	ZJ61M247	3.00	1.75
ZJ61M265	3.25	1.25	ZJ61M267	3.25	1.75
ZJ61M285	3.50	1.25	ZJ61M287	3.50	1.75
ZJ61M305	3.75	1.25	ZJ61M307	3.75	1.75
ZJ61M325	4.00	1.25	ZJ61M327	4.00	1.75
ZJ61M345	4.25	1.25	ZJ61M347	4.25	1.75
ZJ61M365	4.50	1.25	ZJ61M367	4.50	1.75
ZJ61M385	4.75	1.25	ZJ61M387	4.75	1.75
ZJ61M405	5.00	1.25	ZJ61M407	5.00	1.75

Item No.	A	B	Item No.	A	B
ZJ62M243	3.00	3/4	ZJ62M245	3.00	1.25
ZJ62M263	3.25	3/4	ZJ62M265	3.25	1.25
ZJ62M283	3.50	3/4	ZJ62M285	3.50	1.25
ZJ62M303	3.75	3/4	ZJ62M305	3.75	1.25
ZJ62M323	4.00	3/4	ZJ62M325	4.00	1.25
ZJ62M343	4.25	3/4	ZJ62M345	4.25	1.25
ZJ62M363	4.50	3/4	ZJ62M365	4.50	1.25
ZJ62M383	4.75	3/4	ZJ62M385	4.75	1.25
ZJ62M403	5.00	3/4	ZJ62M405	5.00	1.25
ZJ62M244	3.00	1.00	ZJ62M246	3.00	1.50
ZJ62M264	3.25	1.00	ZJ62M266	3.25	1.50
ZJ62M284	3.50	1.00	ZJ62M286	3.50	1.50
ZJ62M304	3.75	1.00	ZJ62M306	3.75	1.50
ZJ62M324	4.00	1.00	ZJ62M326	4.00	1.50
ZJ62M344	4.25	1.00	ZJ62M346	4.25	1.50
ZJ62M364	4.50	1.00	ZJ62M366	4.50	1.50
ZJ62M384	4.75	1.00	ZJ62M386	4.75	1.50
ZJ62M404	5.00	1.00	ZJ62M406	5.00	1.50

Item No.	A	B	Item No.	A	B
ZJ63M243	3.00	3/4	ZJ63M245	3.00	1.25
ZJ63M263	3.25	3/4	ZJ63M265	3.25	1.25
ZJ63M283	3.50	3/4	ZJ63M285	3.50	1.25
ZJ63M303	3.75	3/4	ZJ63M305	3.75	1.25
ZJ63M323	4.00	3/4	ZJ63M325	4.00	1.25
ZJ63M343	4.25	3/4	ZJ63M345	4.25	1.25
ZJ63M363	4.50	3/4	ZJ63M365	4.50	1.25
ZJ63M383	4.75	3/4	ZJ63M385	4.75	1.25
ZJ63M403	5.00	3/4	ZJ63M405	5.00	1.25
ZJ63M244	3.00	1.00	ZJ63M246	3.00	1.50
ZJ63M264	3.25	1.00	ZJ63M266	3.25	1.50
ZJ63M284	3.50	1.00	ZJ63M286	3.50	1.50
ZJ63M304	3.75	1.00	ZJ63M306	3.75	1.50
ZJ63M324	4.00	1.00	ZJ63M326	4.00	1.50
ZJ63M344	4.25	1.00	ZJ63M346	4.25	1.50
ZJ63M364	4.50	1.00	ZJ63M366	4.50	1.50
ZJ63M384	4.75	1.00	ZJ63M386	4.75	1.50
ZJ63M404	5.00	1.00	ZJ63M406	5.00	1.50

Item No.	A	B	Item No.	A	B
ZJ64M242	3.00	1/2	ZJ64M244	3.00	1.00
ZJ64M262	3.25	1/2	ZJ64M264	3.25	1.00
ZJ64M282	3.50	1/2	ZJ64M284	2.50	1.00
ZJ64M302	3.75	1/2	ZJ64M304	3.75	1.00
ZJ64M322	4.00	1/2	ZJ64M324	4.00	1.00
ZJ64M342	4.25	1/2	ZJ64M344	4.25	1.00
ZJ64M362	4.50	1/2	ZJ64M364	4.50	1.00
ZJ64M382	4.75	1/2	ZJ64M384	4.75	1.00
ZJ64M402	5.00	1/2	ZJ64M404	5.00	1.00
ZJ64M243	3.00	3/4	ZJ64M245	3.00	1.25
ZJ64M263	3.25	3/4	ZJ64M265	3.25	1.25
ZJ64M283	3.50	3/4	ZJ64M285	3.50	1.25
ZJ64M303	3.75	3/4	ZJ64M305	3.75	1.25
ZJ64M323	4.00	3/4	ZJ64M325	4.00	1.25
ZJ64M343	4.25	3/4	ZJ64M345	4.25	1.25
ZJ64M363	4.50	3/4	ZJ64M365	4.50	1.25
ZJ64M383	4.75	3/4	ZJ64M385	4.75	1.25
ZJ64M403	5.00	3/4	ZJ64M405	5.00	1.25

ADDITIONAL LENGTHS AVAILABLE TO SUIT YOUR INDIVIDUAL APPLICATIONS. WHEN ORDERING, PLEASE SPECIFY BLIND OR THROUGH WATER HOLE.

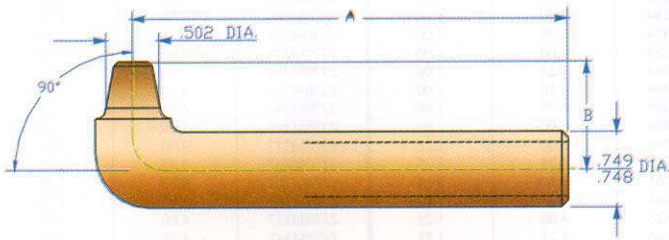

Item No.	A	B	Item No.	A	B
ZJM70244	3.00	1.00	ZJM70246	3.00	1.50
ZJM70264	3.25	1.00	ZJM70266	3.25	1.50
ZJM70844	3.50	1.00	ZJM70846	3.50	1.50
ZJM70304	3.75	1.00	ZJM70306	3.75	1.50
ZJM70324	4.00	1.00	ZJM70326	4.00	1.50
ZJM70344	4.25	1.00	ZJM70346	4.25	1.50
ZJM70364	4.50	1.00	ZJM70366	4.50	1.50
ZJM70384	4.75	1.00	ZJM70386	4.75	1.50
ZJM70404	5.00	1.00	ZJM70406	5.00	1.50
ZJM70245	3.00	1.25	ZJM70247	3.00	1.75
ZJM70265	3.25	1.25	ZJM70267	3.25	1.75
ZJM70285	3.50	1.25	ZJM70287	3.50	1.75
ZJM70305	3.75	1.25	ZJM70307	3.75	1.75
ZJM70325	4.00	1.25	ZJM70327	4.00	1.75
ZJM70345	4.25	1.25	ZJM70347	4.25	1.75
ZJM70365	4.50	1.25	ZJM70367	4.50	1.75
ZJM70385	4.75	1.25	ZJM70387	4.75	1.75
ZJM70405	5.00	1.25	ZJM70407	5.00	1.75

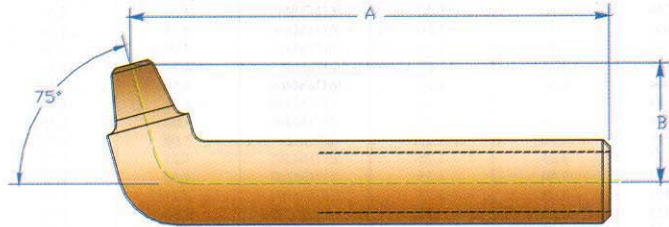

Item No.	A	B	Item No.	A	B
ZJM71244	3.00	1.00	ZJM71246	3.00	1.50
ZJM71264	3.25	1.00	ZJM71266	3.25	1.50
ZJM71844	3.50	1.00	ZJM71846	3.50	1.50
ZJM71304	3.75	1.00	ZJM71306	3.75	1.50
ZJM71324	4.00	1.00	ZJM71326	4.00	1.50
ZJM71344	4.25	1.00	ZJM71346	4.25	1.50
ZJM71364	4.50	1.00	ZJM71366	4.50	1.50
ZJM71384	4.75	1.00	ZJM71386	4.75	1.50
ZJM71404	5.00	1.00	ZJM71406	5.00	1.50
ZJM71245	3.00	1.25	ZJM71247	3.00	1.75
ZJM71265	3.25	1.25	ZJM71267	3.25	1.75
ZJM71285	3.50	1.25	ZJM71287	3.50	1.75
ZJM71305	3.75	1.25	ZJM71307	3.75	1.75
ZJM71325	4.00	1.25	ZJM71327	4.00	1.75
ZJM71345	4.25	1.25	ZJM71347	4.25	1.75
ZJM71365	4.50	1.25	ZJM71367	4.50	1.75
ZJM71385	4.75	1.25	ZJM71387	4.75	1.75
ZJM71405	5.00	1.25	ZJM71407	5.00	1.75

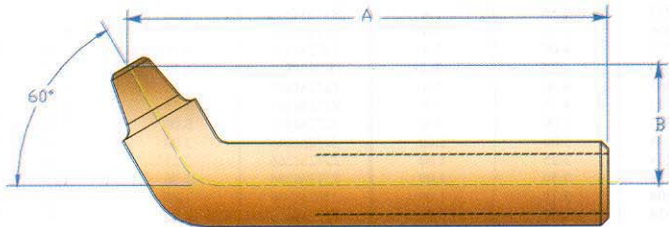

Item No.	A	B	Item No.	A	B
ZJM72244	3.00	1.00	ZJM72246	3.00	1.50
ZJM72264	3.25	1.00	ZJM72266	3.25	1.50
ZJM72844	3.50	1.00	ZJM72846	3.50	1.50
ZJM72304	3.75	1.00	ZJM72306	3.75	1.50
ZJM72324	4.00	1.00	ZJM72326	4.00	1.50
ZJM72344	4.25	1.00	ZJM72346	4.25	1.50
ZJM72364	4.50	1.00	ZJM72366	4.50	1.50
ZJM72384	4.75	1.00	ZJM72386	4.75	1.50
ZJM72404	5.00	1.00	ZJM72406	5.00	1.50
ZJM72245	3.00	1.25	ZJM72247	3.00	1.75
ZJM72265	3.25	1.25	ZJM72267	3.25	1.75
ZJM72285	3.50	1.25	ZJM72287	3.50	1.75
ZJM72305	3.75	1.25	ZJM72307	3.75	1.75
ZJM72325	4.00	1.25	ZJM72327	4.00	1.75
ZJM72345	4.25	1.25	ZJM72347	4.25	1.75
ZJM72365	4.50	1.25	ZJM72367	4.50	1.75
ZJM72385	4.75	1.25	ZJM72387	4.75	1.75
ZJM72405	5.00	1.25	ZJM72407	5.00	1.75

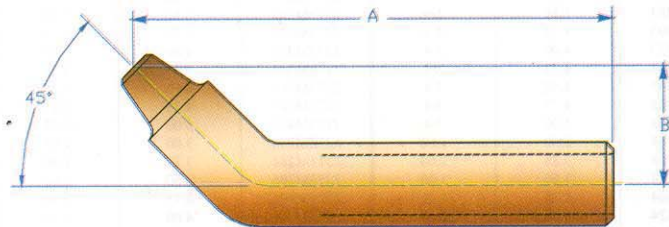

Item No.	A	B	Item No.	A	B
ZJM73243	3.00	3/4	ZJM73245	3.00	1.25
ZJM73263	3.25	3/4	ZJM73265	3.25	1.25
ZJM73843	3.50	3/4	ZJM73845	3.50	1.25
ZJM73303	3.75	3/4	ZJM73305	3.75	1.25
ZJM73323	4.00	3/4	ZJM73325	4.00	1.25
ZJM73343	4.25	3/4	ZJM73345	4.25	1.25
ZJM73363	4.50	3/4	ZJM73365	4.50	1.25
ZJM73383	4.75	3/4	ZJM73385	4.75	1.25
ZJM73403	5.00	3/4	ZJM73405	5.00	1.25
ZJM73244	3.00	1.00	ZJM73246	3.00	1.50
ZJM73264	3.25	1.00	ZJM73266	3.25	1.50
ZJM73284	3.50	1.00	ZJM73286	3.50	1.50
ZJM73304	3.75	1.00	ZJM73306	3.75	1.50
ZJM73324	4.00	1.00	ZJM73326	4.00	1.50
ZJM73344	4.25	1.00	ZJM73346	4.25	1.50
ZJM73364	4.50	1.00	ZJM73366	4.50	1.50
ZJM73384	4.75	1.00	ZJM73386	4.75	1.50
ZJM73404	5.00	1.00	ZJM73406	5.00	1.50

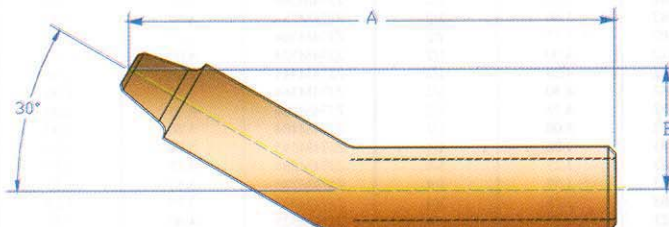

Item No.	A	B	Item No.	A	B
ZJM74242	3.00	1/2	ZJM74244	3.00	1.00
ZJM74262	3.25	1/2	ZJM74264	3.25	1.00
ZJM74842	3.50	1/2	ZJM74844	3.50	1.00
ZJM74302	3.75	1/2	ZJM74304	3.75	1.00
ZJM74322	4.00	1/2	ZJM74324	4.00	1.00
ZJM74342	4.25	1/2	ZJM74344	4.25	1.00
ZJM74362	4.50	1/2	ZJM74364	4.50	1.00
ZJM74382	4.75	1/2	ZJM74384	4.75	1.00
ZJM74402	5.00	1/2	ZJM74404	5.00	1.00
ZJM74243	3.00	3/4	ZJM74245	3.00	1.25
ZJM74263	3.25	3/4	ZJM74265	3.25	1.25
ZJM74283	3.50	3/4	ZJM74285	3.50	1.25
ZJM74303	3.75	3/4	ZJM74305	3.75	1.25
ZJM74323	4.00	3/4	ZJM74325	4.00	1.25
ZJM74343	4.25	3/4	ZJM74345	4.25	1.25
ZJM74363	4.50	3/4	ZJM74365	4.50	1.25
ZJM74383	4.75	3/4	ZJM74385	4.75	1.25
ZJM74403	5.00	3/4	ZJM74405	5.00	1.25

ADDITIONAL LENGTHS AVAILABLE TO SUIT YOUR INDIVIDUAL APPLICATIONS. WHEN ORDERING, PLEASE SPECIFY BLIND OR THROUGH WATER HOLE.

SINGLE BEND MALE ADAPTER SHANK FOR FEMALE CAP

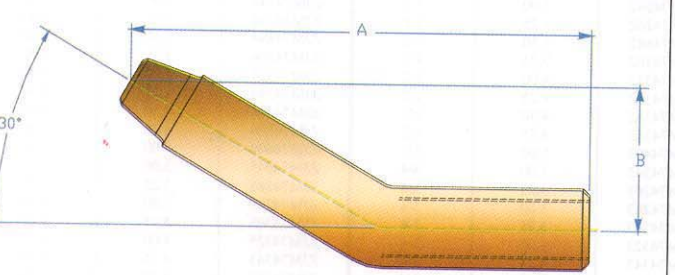
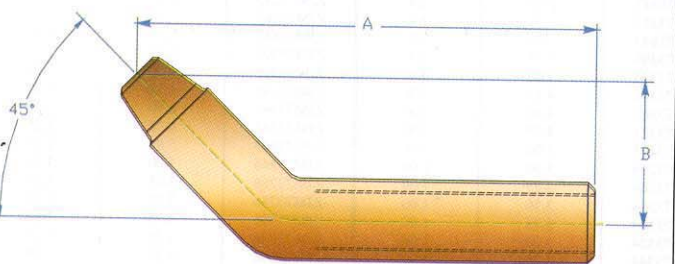
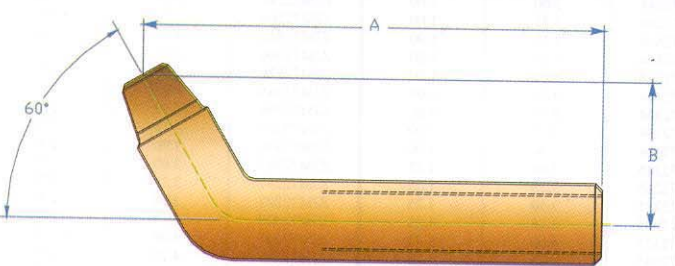
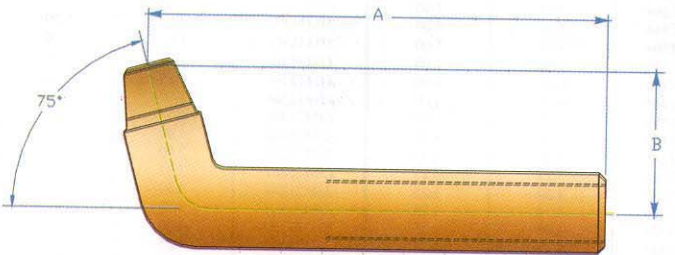
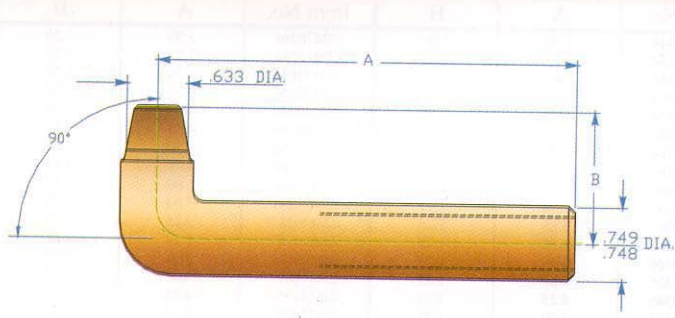

Item No.	A	B	Item No.	A	B
ZJ70M244	3.00	1.00	ZJ70M246	3.00	1.50
ZJ70M264	3.25	1.00	ZJ70M266	3.25	1.50
ZJ70M284	3.50	1.00	ZJ70M286	3.50	1.50
ZJ70M304	3.75	1.00	ZJ70M306	3.75	1.50
ZJ70M324	4.00	1.00	ZJ70M326	4.00	1.50
ZJ70M344	4.25	1.00	ZJ70M346	4.25	1.50
ZJ70M364	4.50	1.00	ZJ70M366	4.50	1.50
ZJ70M384	4.75	1.00	ZJ70M386	4.75	1.50
ZJ70M404	5.00	1.00	ZJ70M406	5.00	1.50
ZJ70M245	3.00	1.25	ZJ70M247	3.00	1.75
ZJ70M265	3.25	1.25	ZJ70M267	3.25	1.75
ZJ70M285	3.50	1.25	ZJ70M287	3.50	1.75
ZJ70M305	3.75	1.25	ZJ70M307	3.75	1.75
ZJ70M325	4.00	1.25	ZJ70M327	4.00	1.75
ZJ70M345	4.25	1.25	ZJ70M347	4.25	1.75
ZJ70M365	4.50	1.25	ZJ70M367	4.50	1.75
ZJ70M385	4.75	1.25	ZJ70M387	4.75	1.75
ZJ70M405	5.00	1.25	ZJ70M407	5.00	1.75

Item No.	A	B	Item No.	A	B
ZJ71M244	3.00	1.00	ZJ71M246	3.00	1.50
ZJ71M264	3.25	1.00	ZJ71M266	3.25	1.50
ZJ71M284	3.50	1.00	ZJ71M286	3.50	1.50
ZJ71M304	3.75	1.00	ZJ71M306	3.75	1.50
ZJ71M324	4.00	1.00	ZJ71M326	4.00	1.50
ZJ71M344	4.25	1.00	ZJ71M346	4.25	1.50
ZJ71M364	4.50	1.00	ZJ71M366	4.50	1.50
ZJ71M384	4.75	1.00	ZJ71M386	4.75	1.50
ZJ71M404	5.00	1.00	ZJ71M406	5.00	1.50
ZJ71M245	3.00	1.25	ZJ71M247	3.00	1.75
ZJ71M265	3.25	1.25	ZJ71M267	3.25	1.75
ZJ71M285	3.50	1.25	ZJ71M287	3.50	1.75
ZJ71M305	3.75	1.25	ZJ71M307	3.75	1.75
ZJ71M325	4.00	1.25	ZJ71M327	4.00	1.75
ZJ71M345	4.25	1.25	ZJ71M347	4.25	1.75
ZJ71M365	4.50	1.25	ZJ71M367	4.50	1.75
ZJ71M385	4.75	1.25	ZJ71M387	4.75	1.75
ZJ71M405	5.00	1.25	ZJ71M407	5.00	1.75

Item No.	A	B	Item No.	A	B
ZJ72M243	3.00	3/4	ZJ72M245	3.00	1.25
ZJ72M263	3.25	3/4	ZJ72M265	3.25	1.25
ZJ72M283	3.50	3/4	ZJ72M285	3.50	1.25
ZJ72M303	3.75	3/4	ZJ72M305	3.75	1.25
ZJ72M323	4.00	3/4	ZJ72M325	4.00	1.25
ZJ72M343	4.25	3/4	ZJ72M345	4.25	1.25
ZJ72M363	4.50	3/4	ZJ72M365	4.50	1.25
ZJ72M383	4.75	3/4	ZJ72M385	4.75	1.25
ZJ72M403	5.00	3/4	ZJ72M405	5.00	1.25
ZJ72M244	3.00	1.00	ZJ72M246	3.00	1.50
ZJ72M264	3.25	1.00	ZJ72M266	3.25	1.50
ZJ72M284	3.50	1.00	ZJ72M286	3.50	1.50
ZJ72M304	3.75	1.00	ZJ72M306	3.75	1.50
ZJ72M324	4.00	1.00	ZJ72M326	4.00	1.50
ZJ72M344	4.25	1.00	ZJ72M346	4.25	1.50
ZJ72M364	4.50	1.00	ZJ72M366	4.50	1.50
ZJ72M384	4.75	1.00	ZJ72M386	4.75	1.50
ZJ72M404	5.00	1.00	ZJ72M406	5.00	1.50

Item No.	A	B	Item No.	A	B
ZJ73M243	3.00	3/4	ZJ73M245	3.00	1.25
ZJ73M263	3.25	3/4	ZJ73M265	3.25	1.25
ZJ73M283	3.50	3/4	ZJ73M285	3.50	1.25
ZJ73M303	3.75	3/4	ZJ73M305	3.75	1.25
ZJ73M323	4.00	3/4	ZJ73M325	4.00	1.25
ZJ73M343	4.25	3/4	ZJ73M345	4.25	1.25
ZJ73M363	4.50	3/4	ZJ73M365	4.50	1.25
ZJ73M383	4.75	3/4	ZJ73M385	4.75	1.25
ZJ73M403	5.00	3/4	ZJ73M405	5.00	1.25
ZJ73M244	3.00	1.00	ZJ73M246	3.00	1.50
ZJ73M264	3.25	1.00	ZJ73M266	3.25	1.50
ZJ73M284	3.50	1.00	ZJ73M286	3.50	1.50
ZJ73M304	3.75	1.00	ZJ73M306	3.75	1.50
ZJ73M324	4.00	1.00	ZJ73M326	4.00	1.50
ZJ73M344	4.25	1.00	ZJ73M346	4.25	1.50
ZJ73M364	4.50	1.00	ZJ73M366	4.50	1.50
ZJ73M384	4.75	1.00	ZJ73M386	4.75	1.50
ZJ73M404	5.00	1.00	ZJ73M406	5.00	1.50

Item No.	A	B	Item No.	A	B
ZJ74M242	3.00	1/2	ZJ74M244	3.00	1.00
ZJ74M262	3.25	1/2	ZJ74M264	3.25	1.00
ZJ74M282	3.50	1/2	ZJ74M284	3.50	1.00
ZJ74M302	3.75	1/2	ZJ74M304	3.75	1.00
ZJ74M322	4.00	1/2	ZJ74M324	4.00	1.00
ZJ74M342	4.25	1/2	ZJ74M344	4.25	1.00
ZJ74M362	4.50	1/2	ZJ74M364	4.50	1.00
ZJ74M382	4.75	1/2	ZJ74M384	4.75	1.00
ZJ74M402	5.00	1/2	ZJ74M404	5.00	1.00
ZJ74M243	3.00	3/4	ZJ74M245	3.00	1.25
ZJ74M263	3.25	3/4	ZJ74M265	3.25	1.25
ZJ74M283	3.50	3/4	ZJ74M285	3.50	1.25
ZJ74M303	3.75	3/4	ZJ74M305	3.75	1.25
ZJ74M323	4.00	3/4	ZJ74M325	4.00	1.25
ZJ74M343	4.25	3/4	ZJ74M345	4.25	1.25
ZJ74M363	4.50	3/4	ZJ74M365	4.50	1.25
ZJ74M383	4.75	3/4	ZJ74M385	4.75	1.25
ZJ74M403	5.00	3/4	ZJ74M405	5.00	1.25

ADDITIONAL LENGTHS AVAILABLE TO SUIT YOUR INDIVIDUAL APPLICATIONS.
WHEN ORDERING, PLEASE SPECIFY BLIND OR THROUGH WATER HOLE.

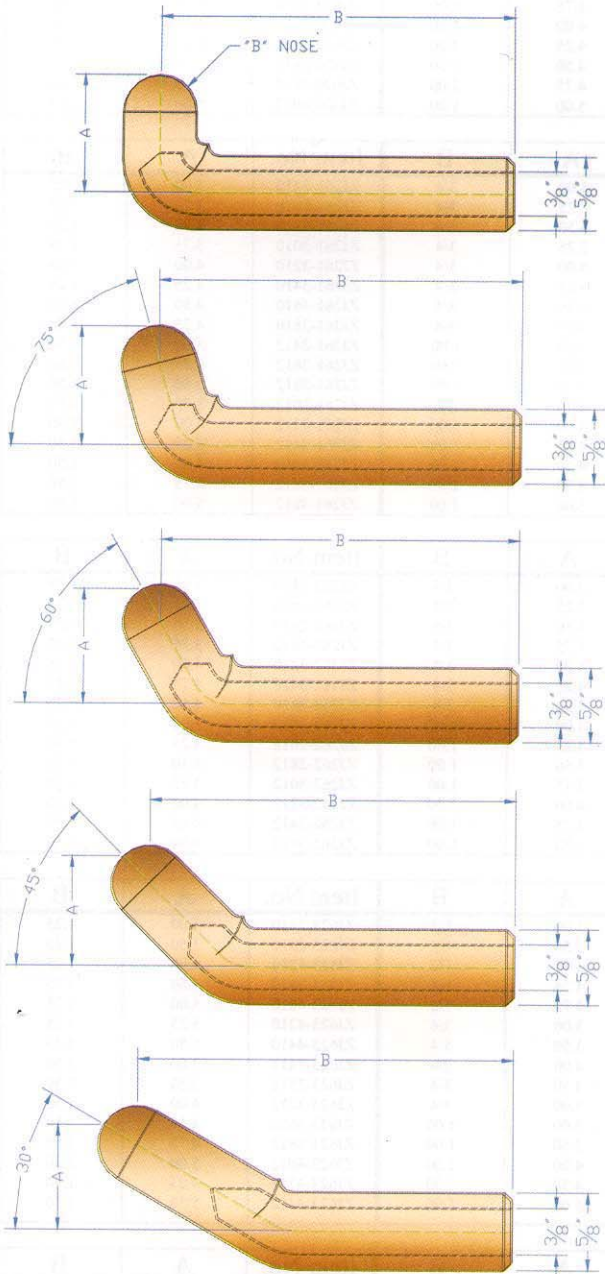
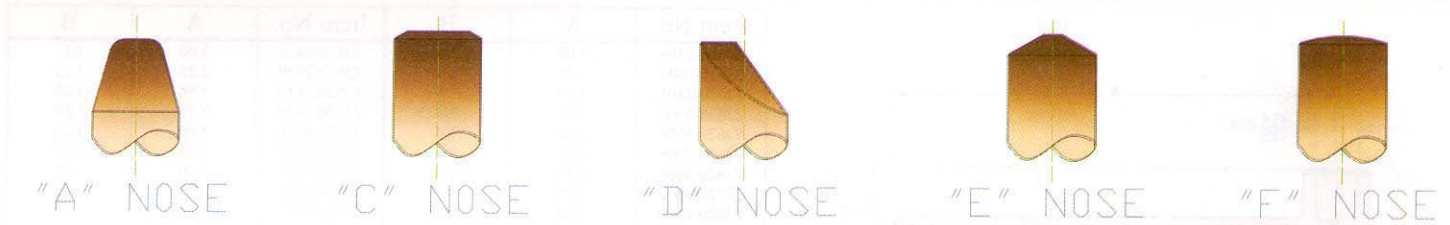

Item No.	A	B	Item No.	A	B
ZJ90-100-*	3/4	2.50	ZJ90-110-*	1.25	2.50
ZJ90-101-*	3/4	3.00	ZJ90-111-*	1.25	3.00
ZJ90-102-*	3/4	3.50	ZJ90-112-*	1.25	3.50
ZJ90-103-*	3/4	4.00	ZJ90-113-*	1.25	4.00
ZJ90-104-*	3/4	4.50	ZJ90-114-*	1.25	4.50
ZJ90-105-*	1.00	2.50	ZJ90-115-*	1.50	2.50
ZJ90-106-*	1.00	3.00	ZJ90-116-*	1.50	3.00
ZJ90-107-*	1.00	3.50	ZJ90-117-*	1.50	3.50
ZJ90-108-*	1.00	4.00	ZJ90-118-*	1.50	4.00
ZJ90-109-*	1.00	4.50	ZJ90-119-*	1.50	4.00

Item No.	A	B	Item No.	A	B
ZJ75-120-*	3/4	2.50	ZJ75-130-*	1.25	2.50
ZJ75-121-*	3/4	3.00	ZJ75-131-*	1.25	3.00
ZJ75-122-*	3/4	3.50	ZJ75-132-*	1.25	3.50
ZJ75-123-*	3/4	4.00	ZJ75-133-*	1.25	4.00
ZJ75-124-*	3/4	4.50	ZJ75-134-*	1.25	4.50
ZJ75-125-*	1.00	2.50	ZJ75-135-*	1.50	2.50
ZJ75-126-*	1.00	3.00	ZJ75-136-*	1.50	3.00
ZJ75-127-*	1.00	3.50	ZJ75-137-*	1.50	3.50
ZJ75-128-*	1.00	4.00	ZJ75-138-*	1.50	4.00
ZJ75-129-*	1.00	4.50	ZJ75-139-*	1.50	4.50

Item No.	A	B	Item No.	A	B
ZJ60-140-*	3/4	2.50	ZJ60-150-*	1.25	2.50
ZJ60-141-*	3/4	3.00	ZJ60-151-*	1.25	3.00
ZJ60-142-*	3/4	3.50	ZJ60-152-*	1.25	3.50
ZJ60-143-*	3/4	4.00	ZJ60-153-*	1.25	4.00
ZJ60-144-*	3/4	4.50	ZJ60-154-*	1.25	4.50
ZJ60-145-*	1.00	2.50	ZJ60-155-*	1.50	2.50
ZJ60-146-*	1.00	3.00	ZJ60-156-*	1.50	3.00
ZJ60-147-*	1.00	3.50	ZJ60-157-*	1.50	3.50
ZJ60-148-*	1.00	4.00	ZJ60-158-*	1.50	4.00
ZJ60-149-*	1.00	4.50	ZJ60-159-*	1.50	4.50

Item No.	A	B	Item No.	A	B
ZJ45-160-*	1/2	2.50	ZJ45-169-*	1.00	2.50
ZJ45-161-*	1/2	3.00	ZJ45-170-*	1.00	3.00
ZJ45-162-*	1/2	3.50	ZJ45-171-*	1.00	3.50
ZJ45-163-*	1/2	4.00	ZJ45-172-*	1.00	4.00
ZJ45-164-*	1/2	4.50	ZJ45-173-*	1.00	4.50
ZJ45-165-*	3/4	2.50	ZJ45-174-*	1.25	2.50
ZJ45-165-*	3/4	3.00	ZJ45-175-*	1.25	3.00
ZJ45-166-*	3/4	3.50	ZJ45-176-*	1.25	3.50
ZJ45-167-*	3/4	4.00	ZJ45-177-*	1.25	4.00
ZJ45-168-*	3/4	4.50	ZJ45-178-*	1.25	4.50

Item No.	A	B	Item No.	A	B
ZJ30-179-*	1/2	2.50	ZJ30-189-*	1.00	2.50
ZJ30-180-*	1/2	3.00	ZJ30-190-*	1.00	3.00
ZJ30-181-*	1/2	3.50	ZJ30-191-*	1.00	3.50
ZJ30-182-*	1/2	4.00	ZJ30-192-*	1.00	4.00
ZJ30-183-*	1/2	4.50	ZJ30-193-*	1.00	4.50
ZJ30-184-*	3/4	2.50	ZJ30-194-*	1.25	2.50
ZJ30-185-*	3/4	3.00	ZJ30-195-*	1.25	3.00
ZJ30-186-*	3/4	3.50	ZJ30-196-*	1.25	3.50
ZJ30-187-*	3/4	4.00	ZJ30-197-*	1.25	4.00
ZJ30-188-*	3/4	4.50	ZJ30-198-*	1.25	4.50

ADDITIONAL LENGTHS AVAILABLE TO UP ON YOR REQUEST.
WHEN ORDERING, PLEASE SPECIFY NOSE TYPE;

EXAMPLE

OFF SET ANGLE PART # NOSE TYPE

ZJ 90 100 A

- ZJ90-100-A----- USE A FOR NOSE "A"
- ZJ90-100-B----- USE B FOR NOSE "B"
- ZJ90-100-C----- USE C FOR NOSE "C"
- ZJ90-100-D----- USE D FOR NOSE "D"
- ZJ90-100-E----- USE E FOR NOSE "E"
- ZJ90-100-F----- USE F FOR NOSE "F"

SINGLE BEND FEMALE ADAPTER SHANK FOR MALE CAP

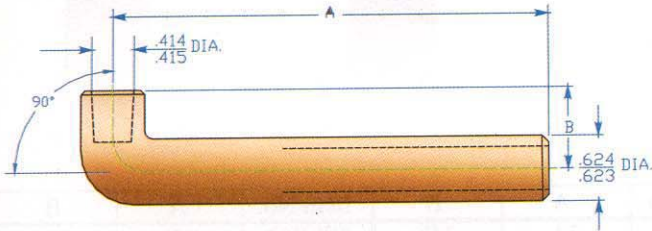

Item No.	A	B	Item No.	A	B
ZJ620-2406	3.00	3/4	ZJ620-2410	3.00	1.25
ZJ620-2606	3.25	3/4	ZJ620-2610	3.25	1.25
ZJ620-2806	3.50	3/4	ZJ620-2810	3.50	1.25
ZJ620-3006	3.75	3/4	ZJ620-3010	3.75	1.25
ZJ620-3206	4.00	3/4	ZJ620-3210	4.00	1.25
ZJ620-3406	4.25	3/4	ZJ620-3410	4.25	1.25
ZJ620-3606	4.50	3/4	ZJ620-3610	4.50	1.25
ZJ620-3806	4.75	3/4	ZJ620-3810	4.75	1.25
ZJ620-2408	3.00	1.00	ZJ620-2412	3.00	1.50
ZJ620-2608	3.25	1.00	ZJ620-2612	3.25	1.50
ZJ620-2808	3.50	1.00	ZJ620-2812	3.50	1.50
ZJ620-3008	3.75	1.00	ZJ620-3012	3.75	1.50
ZJ620-3208	4.00	1.00	ZJ620-3212	4.00	1.50
ZJ620-3408	4.25	1.00	ZJ620-3412	4.25	1.50
ZJ620-3608	4.50	1.00	ZJ620-3612	4.50	1.50
ZJ620-3808	4.75	1.00	ZJ620-3812	4.75	1.50
ZJ620-4008	5.00	1.00	ZJ620-4012	5.00	1.50

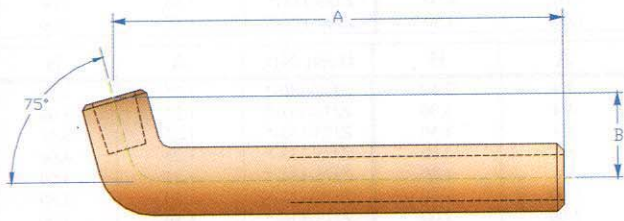

Item No.	A	B	Item No.	A	B
ZJ261-2406	3.00	3/4	ZJ261-2410	3.00	1.25
ZJ261-2606	3.25	3/4	ZJ261-2610	3.25	1.25
ZJ261-2806	3.50	3/4	ZJ261-2810	3.50	1.25
ZJ261-3006	3.75	3/4	ZJ261-3010	3.75	1.25
ZJ261-3206	4.00	3/4	ZJ261-3210	4.00	1.25
ZJ261-3406	4.25	3/4	ZJ261-3410	4.25	1.25
ZJ261-3606	4.50	3/4	ZJ261-3610	4.50	1.25
ZJ261-3806	4.75	3/4	ZJ261-3810	4.75	1.25
ZJ261-2408	3.00	1.00	ZJ261-2412	3.00	1.50
ZJ261-2608	3.25	1.00	ZJ261-2612	3.25	1.50
ZJ261-2808	3.50	1.00	ZJ261-2812	3.50	1.50
ZJ261-3008	3.75	1.00	ZJ261-3012	3.75	1.50
ZJ261-3208	4.00	1.00	ZJ261-3212	4.00	1.50
ZJ261-3408	4.25	1.00	ZJ261-3412	4.25	1.50
ZJ261-3608	4.50	1.00	ZJ261-3612	4.50	1.50
ZJ261-3808	4.75	1.00	ZJ261-3812	4.75	1.50
ZJ261-4008	5.00	1.00	ZJ261-4012	5.00	1.50

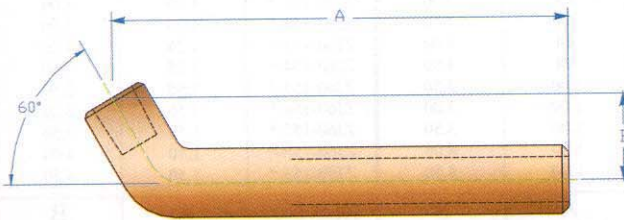

Item No.	A	B	Item No.	A	B
ZJ262-2406	3.00	3/4	ZJ262-2410	3.00	1.25
ZJ262-2606	3.25	3/4	ZJ262-2610	3.25	1.25
ZJ262-2806	3.50	3/4	ZJ262-2810	3.50	1.25
ZJ262-3006	3.75	3/4	ZJ262-3010	3.75	1.25
ZJ262-3206	4.00	3/4	ZJ262-3210	4.00	1.25
ZJ262-3406	4.25	3/4	ZJ262-3410	4.25	1.25
ZJ262-3606	4.50	3/4	ZJ262-3610	4.50	1.25
ZJ262-2408	3.00	1.00	ZJ262-2412	3.00	1.50
ZJ262-2608	3.25	1.00	ZJ262-2612	3.25	1.50
ZJ262-2808	3.50	1.00	ZJ262-2812	3.50	1.50
ZJ262-3008	3.75	1.00	ZJ262-3012	3.75	1.50
ZJ262-3208	4.00	1.00	ZJ262-3212	4.00	1.50
ZJ262-3408	4.25	1.00	ZJ262-3412	4.25	1.50
ZJ262-3608	4.50	1.00	ZJ262-3612	4.50	1.50

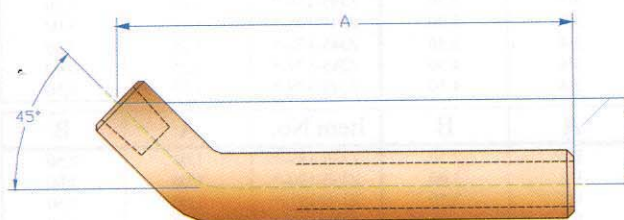

Item No.	A	B	Item No.	A	B
ZJ623-2404	3.00	1/2	ZJ623-2410	3.00	1.25
ZJ623-2804	3.50	1/2	ZJ623-2810	3.50	1.25
ZJ623-3004	3.75	1/2	ZJ623-3210	4.00	1.25
ZJ623-3404	4.25	1/2	ZJ623-3610	4.50	1.25
ZJ623-3804	4.75	1/2	ZJ623-4010	5.00	1.25
ZJ623-2406	3.00	3/4	ZJ623-4210	5.25	1.25
ZJ623-2806	3.50	3/4	ZJ623-4410	5.50	1.25
ZJ623-3206	4.00	3/4	ZJ623-2412	3.00	1.50
ZJ623-3606	4.50	3/4	ZJ623-2812	3.50	1.50
ZJ623-4006	5.00	3/4	ZJ623-3212	4.00	1.50
ZJ623-2408	3.00	1.00	ZJ623-3612	4.50	1.50
ZJ623-2808	3.50	1.00	ZJ623-3812	4.75	1.50
ZJ623-3208	4.00	1.00	ZJ623-4012	5.00	1.50
ZJ623-3608	4.50	1.00	ZJ623-4212	5.25	1.50
ZJ623-4008	5.00	1.00	ZJ623-4412	5.50	1.50

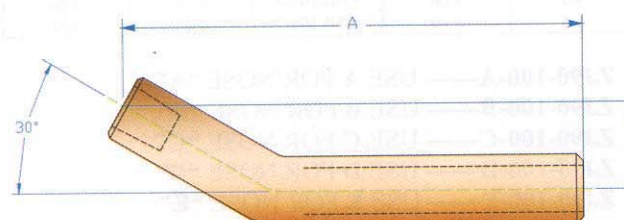

Item No.	A	B	Item No.	A	B
ZJ624-2804	3.50	1/2	ZJ624-3210	4.00	1.25
ZJ624-3204	4.00	1/2	ZJ624-3410	4.25	1.25
ZJ624-3604	4.50	1/2	ZJ624-3610	4.50	1.25
ZJ624-4004	5.00	1/2	ZJ624-3810	4.75	1.25
ZJ624-3206	4.00	3/4	ZJ624-4010	5.00	1.25
ZJ624-3606	4.50	3/4	ZJ624-4210	5.25	1.25
ZJ624-4006	5.00	3/4	ZJ624-4410	5.50	1.25
ZJ624-4206	5.25	3/4	ZJ624-3212	4.00	1.50
ZJ624-3208	4.00	1.00	ZJ624-3612	4.50	1.50
ZJ624-3608	4.50	1.00	ZJ624-4012	5.00	1.50
ZJ624-4008	5.00	1.00	ZJ624-4212	5.25	1.50
ZJ624-4208	5.25	1.00	ZJ624-4412	5.50	1.50

ADDITIONAL SIZES AVAILABLE UPON YOUR REQUEST
 WHEN ORDERING, PLEASE SPECIFY **BLIND** OR **THROUGH** WATER HOLE.

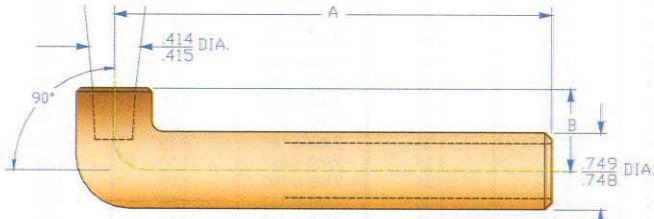

Item No.	A	B	Item No.	A	B
ZJ305-243	3.00	3/4	ZJ305-245	3.00	1.25
ZJ305-263	3.25	3/4	ZJ305-265	3.25	1.25
ZJ305-283	3.50	3/4	ZJ305-285	3.50	1.25
ZJ305-303	3.75	3/4	ZJ305-305	3.75	1.25
ZJ305-323	4.00	3/4	ZJ305-325	4.00	1.25
ZJ305-343	4.25	3/4	ZJ305-345	4.25	1.25
ZJ305-363	4.50	3/4	ZJ305-365	4.50	1.25
ZJ305-383	4.75	3/4	ZJ305-385	4.75	1.25
ZJ305-403	5.00	3/4	ZJ305-405	5.00	1.25
ZJ305-443	5.50	3/4	ZJ305-445	5.50	1.25
ZJ305-244	3.00	1.00	ZJ305-246	3.00	1.50
ZJ305-264	3.25	1.00	ZJ305-266	3.25	1.50
ZJ305-284	3.50	1.00	ZJ305-286	3.50	1.50
ZJ305-304	3.75	1.00	ZJ305-306	3.75	1.50
ZJ305-324	4.00	1.00	ZJ305-326	4.00	1.50
ZJ305-344	4.25	1.00	ZJ305-346	4.25	1.50
ZJ305-364	4.50	1.00	ZJ305-366	4.50	1.50
ZJ305-384	4.75	1.00	ZJ305-386	4.75	1.50
ZJ305-404	5.00	1.00	ZJ305-406	5.00	1.50
ZJ305-444	5.50	1.00	ZJ305-446	5.50	1.50

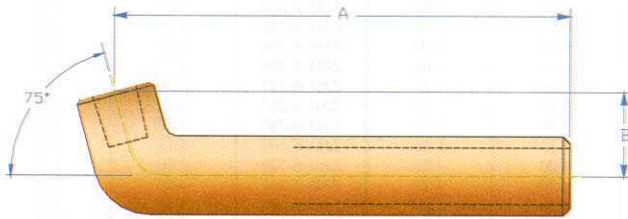

Item No.	A	B	Item No.	A	B
ZJ315-243	3.00	3/4	ZJ315-245	3.00	1.25
ZJ315-263	3.25	3/4	ZJ315-265	3.25	1.25
ZJ315-283	3.50	3/4	ZJ315-285	3.50	1.25
ZJ315-303	3.75	3/4	ZJ315-305	3.75	1.25
ZJ315-323	4.00	3/4	ZJ315-325	4.00	1.25
ZJ315-343	4.25	3/4	ZJ312-345	4.25	1.25
ZJ315-363	4.50	3/4	ZJ312-365	4.50	1.25
ZJ315-383	4.75	3/4	ZJ312-385	4.75	1.25
ZJ315-403	5.00	3/4	ZJ312-405	5.00	1.25
ZJ315-443	5.50	3/4	ZJ312-445	4.50	1.25
ZJ315-244	3.00	1.00	ZJ312-246	3.00	1.50
ZJ315-264	3.25	1.00	ZJ312-266	3.25	1.50
ZJ315-284	3.50	1.00	ZJ312-286	3.50	1.50
ZJ315-304	3.75	1.00	ZJ312-306	3.75	1.50
ZJ315-324	4.00	1.00	ZJ312-326	4.00	1.50
ZJ315-344	4.25	1.00	ZJ312-346	4.25	1.50
ZJ315-364	4.50	1.00	ZJ312-366	4.50	1.50
ZJ315-384	4.75	1.00	ZJ312-386	4.75	1.50
ZJ315-404	5.00	1.00	ZJ312-406	5.00	1.50
ZJ315-444	5.50	1.00	ZJ312-446	5.50	1.50

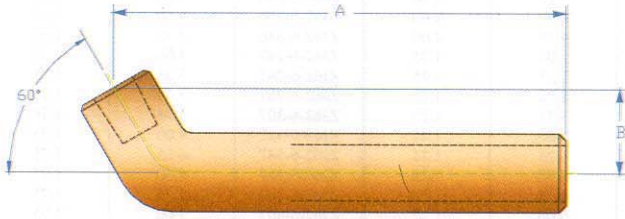

Item No.	A	B	Item No.	A	B
ZJ325-243	3.00	3/4	ZJ325-245	3.00	1.25
ZJ325-263	3.25	3/4	ZJ325-265	3.25	1.25
ZJ325-283	3.50	3/4	ZJ325-285	3.50	1.25
ZJ325-303	3.75	3/4	ZJ325-305	3.75	1.25
ZJ325-323	4.00	3/4	ZJ325-325	4.00	1.25
ZJ325-343	4.25	3/4	ZJ325-345	4.25	1.25
ZJ325-363	4.50	3/4	ZJ325-365	4.50	1.25
ZJ325-383	4.75	3/4	ZJ325-385	4.75	1.25
ZJ325-403	5.00	3/4	ZJ325-405	5.00	1.25
ZJ325-443	5.50	3/4	ZJ325-445	5.50	1.25
ZJ325-244	3.00	1.00	ZJ325-246	3.00	1.50
ZJ325-264	3.25	1.00	ZJ325-266	3.25	1.50
ZJ325-284	3.50	1.00	ZJ325-286	3.50	1.50
ZJ325-304	3.75	1.00	ZJ325-306	3.75	1.50
ZJ325-324	4.00	1.00	ZJ325-326	4.00	1.50
ZJ325-344	4.25	1.00	ZJ325-346	4.25	1.50
ZJ325-364	4.50	1.00	ZJ325-366	4.50	1.50
ZJ325-384	4.75	1.00	ZJ325-386	4.75	1.50
ZJ325-404	5.00	1.00	ZJ325-406	5.00	1.50
ZJ325-444	5.50	1.00	ZJ325-446	5.50	1.50

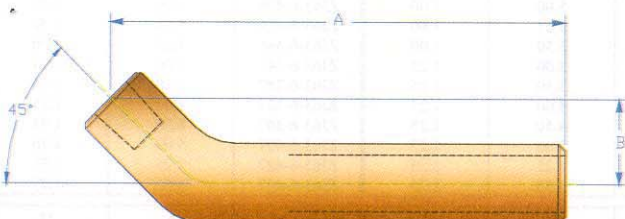

Item No.	A	B	Item No.	A	B
ZJ335-243	3.00	3/4	ZJ335-245	3.00	1.25
ZJ335-283	3.50	3/4	ZJ335-285	3.50	1.25
ZJ335-323	4.00	3/4	ZJ335-325	4.00	1.25
ZJ335-363	4.50	3/4	ZJ335-365	4.50	1.25
ZJ335-403	5.00	3/4	ZJ335-405	5.00	1.25
ZJ335-423	5.25	3/4	ZJ335-425	5.25	1.25
ZJ335-443	5.50	3/4	ZJ335-445	5.50	1.25
ZJ335-244	3.00	1.00	ZJ335-246	3.00	1.50
ZJ335-284	3.50	1.00	ZJ335-286	3.50	1.50
ZJ335-324	4.00	1.00	ZJ335-326	4.00	1.50
ZJ335-364	4.50	1.00	ZJ335-366	4.50	1.50
ZJ335-404	5.00	1.00	ZJ335-406	5.00	1.50
ZJ335-424	5.25	1.00	ZJ335-426	5.25	1.50
ZJ335-444	5.50	1.00	ZJ335-446	5.50	1.50

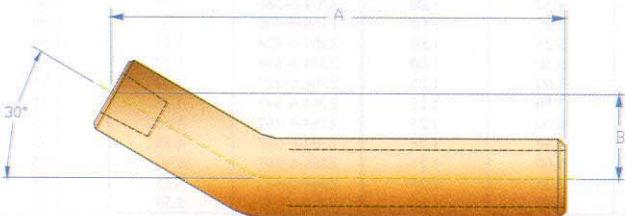

Item No.	A	B	Item No.	A	B
ZJ345-283	3.50	3/4	ZJ345-325	4.00	1.25
ZJ345-323	4.00	3/4	ZJ345-345	4.25	1.25
ZJ345-363	4.50	3/4	ZJ345-365	4.50	1.25
ZJ345-403	5.00	3/4	ZJ345-405	5.00	1.25
ZJ345-423	5.25	3/4	ZJ345-425	5.25	1.25
ZJ345-443	5.50	3/4	ZJ345-445	5.50	1.25
ZJ345-284	3.50	1.00	ZJ345-326	4.00	1.50
ZJ345-324	4.00	1.00	ZJ345-346	4.25	1.50
ZJ345-364	4.50	1.00	ZJ345-366	4.50	1.50
ZJ345-404	5.00	1.00	ZJ345-406	5.00	1.50
ZJ345-424	5.25	1.00	ZJ345-426	5.25	1.50
ZJ345-444	5.50	1.00	ZJ345-446	5.50	1.50

ADDITIONAL LENGTHS AVAILABLE TO SUIT YOUR INDIVIDUAL APPLICATIONS.
WHEN ORDERING, PLEASE SPECIFY BLIND OR THROUGH WATER HOLE.

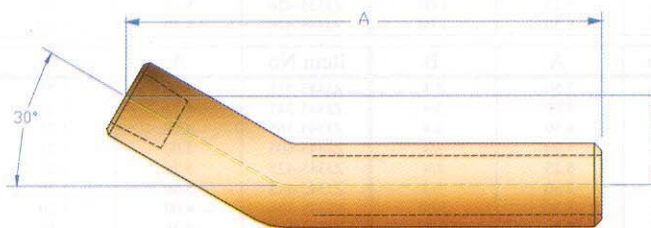
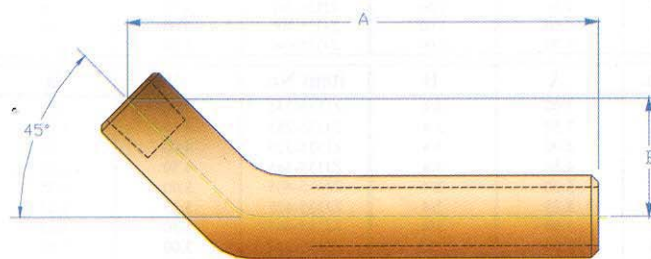
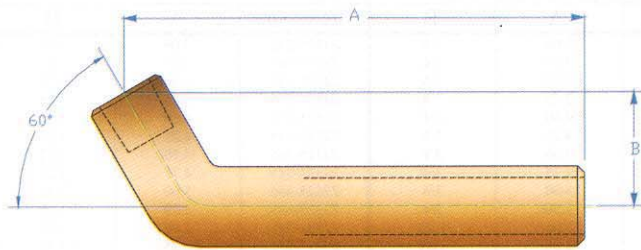
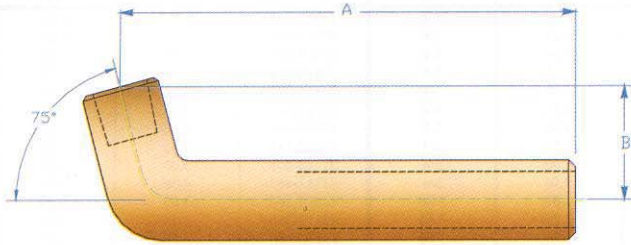
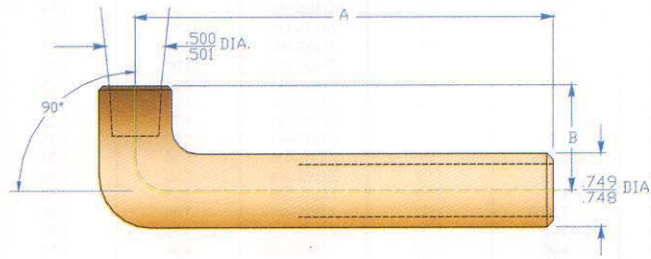

Item No.	A	B	Item No.	A	B
ZJ60-6-244	3.00	1.00	ZJ60-6-246	3.00	1.50
ZJ60-6-264	3.25	1.00	ZJ60-6-266	3.25	1.50
ZJ60-6-284	3.50	1.00	ZJ60-6-286	3.50	1.50
ZJ60-6-304	3.75	1.00	ZJ60-6-306	3.75	1.50
ZJ60-6-324	4.00	1.00	ZJ60-6-326	4.00	1.50
ZJ60-6-344	4.25	1.00	ZJ60-6-346	4.25	1.50
ZJ60-6-364	4.50	1.00	ZJ60-6-366	4.50	1.50
ZJ60-6-384	4.75	1.00	ZJ60-6-386	4.75	1.50
ZJ60-6-245	3.00	1.25	ZJ60-6-247	3.00	1.75
ZJ60-6-265	3.25	1.25	ZJ60-6-267	3.25	1.75
ZJ60-6-285	3.50	1.25	ZJ60-6-287	3.50	1.75
ZJ60-6-305	3.75	1.25	ZJ60-6-307	3.75	1.75
ZJ60-6-325	4.00	1.25	ZJ60-6-327	4.00	1.75
ZJ60-6-345	4.25	1.25	ZJ60-6-347	4.25	1.75
ZJ60-6-365	4.50	1.25	ZJ60-6-367	4.50	1.75
ZJ60-6-385	4.75	1.25	ZJ60-6-387	4.75	1.75
ZJ60-6-405	5.00	1.25	ZJ60-6-407	5.00	1.75

Item No.	A	B	Item No.	A	B
ZJ61-6-244	3.00	1.00	ZJ61-6-246	3.00	1.50
ZJ61-6-264	3.25	1.00	ZJ61-6-266	3.25	1.50
ZJ61-6-284	3.50	1.00	ZJ61-6-286	3.50	1.50
ZJ61-6-304	3.75	1.00	ZJ61-6-306	3.75	1.50
ZJ61-6-324	4.00	1.00	ZJ61-6-326	4.00	1.50
ZJ61-6-344	4.25	1.00	ZJ61-6-346	4.25	1.50
ZJ61-6-364	4.50	1.00	ZJ61-6-366	4.50	1.50
ZJ61-6-384	4.75	1.00	ZJ61-6-386	4.75	1.50
ZJ61-6-245	3.00	1.25	ZJ61-6-247	3.00	1.75
ZJ61-6-265	3.25	1.25	ZJ61-6-267	3.25	1.75
ZJ61-6-285	3.50	1.25	ZJ61-6-287	3.50	1.75
ZJ61-6-305	3.75	1.25	ZJ61-6-307	3.75	1.75
ZJ61-6-325	4.00	1.25	ZJ61-6-327	4.00	1.75
ZJ61-6-345	4.25	1.25	ZJ61-6-347	4.25	1.75
ZJ61-6-365	4.50	1.25	ZJ61-6-367	4.50	1.75
ZJ61-6-385	4.75	1.25	ZJ61-6-387	4.75	1.75
ZJ61-6-405	5.00	1.25	ZJ61-6-407	5.00	1.75

Item No.	A	B	Item No.	A	B
ZJ62-6-244	3.00	1.00	ZJ62-6-246	3.00	1.50
ZJ62-6-264	3.25	1.00	ZJ62-6-266	3.25	1.50
ZJ62-6-284	3.50	1.00	ZJ62-6-286	3.50	1.50
ZJ62-6-304	3.75	1.00	ZJ62-6-306	3.75	1.50
ZJ62-6-324	4.00	1.00	ZJ62-6-326	4.00	1.50
ZJ62-6-344	4.25	1.00	ZJ62-6-346	4.25	1.50
ZJ62-6-364	4.50	1.00	ZJ62-6-366	4.50	1.50
ZJ62-6-384	4.75	1.00	ZJ62-6-386	4.75	1.50
ZJ62-6-245	3.00	1.25	ZJ62-6-247	3.00	1.75
ZJ62-6-265	3.25	1.25	ZJ62-6-267	3.25	1.75
ZJ62-6-285	3.50	1.25	ZJ62-6-287	3.50	1.75
ZJ62-6-305	3.75	1.25	ZJ62-6-307	3.75	1.75
ZJ62-6-325	4.00	1.25	ZJ62-6-327	4.00	1.75
ZJ62-6-345	4.25	1.25	ZJ62-6-347	4.25	1.75
ZJ62-6-365	4.50	1.25	ZJ62-6-367	4.50	1.75
ZJ62-6-385	4.75	1.25	ZJ62-6-387	4.75	1.75
ZJ62-6-405	5.00	1.25	ZJ62-6-407	5.00	1.75

Item No.	A	B	Item No.	A	B
ZJ63-6-244	3.00	1.00	ZJ63-6-246	3.00	1.50
ZJ63-6-284	3.50	1.00	ZJ63-6-286	3.50	1.50
ZJ63-6-324	4.00	1.00	ZJ63-6-326	4.00	1.50
ZJ63-6-364	4.50	1.00	ZJ63-6-366	4.50	1.50
ZJ63-6-404	5.00	1.00	ZJ63-6-406	5.00	1.50
ZJ63-6-424	5.25	1.00	ZJ63-6-426	5.25	1.50
ZJ63-6-444	5.50	1.00	ZJ63-6-446	5.50	1.50
ZJ63-6-245	3.00	1.25	ZJ63-6-247	3.00	1.75
ZJ63-6-285	3.50	1.25	ZJ63-6-287	3.50	1.75
ZJ63-6-325	4.00	1.25	ZJ63-6-327	4.00	1.75
ZJ63-6-365	4.50	1.25	ZJ63-6-367	4.50	1.75
ZJ63-6-405	5.00	1.25	ZJ63-6-407	5.00	1.75
ZJ63-6-425	5.25	1.25	ZJ63-6-427	5.25	1.75
ZJ63-6-445	5.50	1.25	ZJ63-6-447	5.50	1.75

Item No.	A	B	Item No.	A	B
ZJ64-6-244	3.00	1.00	ZJ64-6-326	4.00	1.50
ZJ64-6-284	3.50	1.00	ZJ64-6-346	4.25	1.50
ZJ64-6-324	4.00	1.00	ZJ64-6-366	4.50	1.50
ZJ64-6-364	4.50	1.00	ZJ64-6-386	4.75	1.50
ZJ64-6-404	5.00	1.00	ZJ64-6-406	5.00	1.50
ZJ64-6-424	5.25	1.00	ZJ64-6-426	5.25	1.50
ZJ64-6-444	5.50	1.00	ZJ64-6-446	5.50	1.50
ZJ64-6-245	3.00	1.25	ZJ64-6-327	4.00	1.75
ZJ64-6-285	3.50	1.25	ZJ64-6-347	4.25	1.75
ZJ64-6-325	4.00	1.25	ZJ64-6-367	4.50	1.75
ZJ64-6-365	4.50	1.25	ZJ64-6-387	4.75	1.75
ZJ64-6-405	5.00	1.25	ZJ64-6-407	5.00	1.75
ZJ64-6-425	5.25	1.25	ZJ64-6-427	5.25	1.75
ZJ64-6-445	5.50	1.25	ZJ64-6-447	5.50	1.75

ADDITIONAL LENGTHS AVAILABLE TO SUIT YOUR INDIVIDUAL APPLICATIONS.
WHEN ORDERING, PLEASE SPECIFY BLIND OR THROUGH WATER HOLE.